

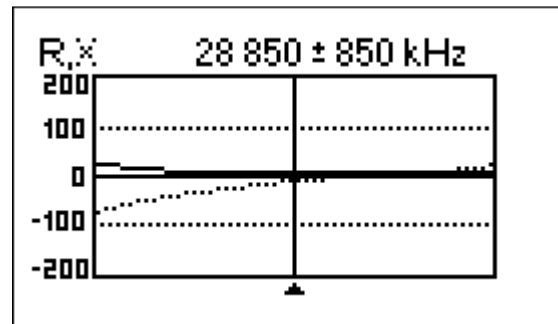

10 metri: 28.000 – 29.700

Delta MOPLK

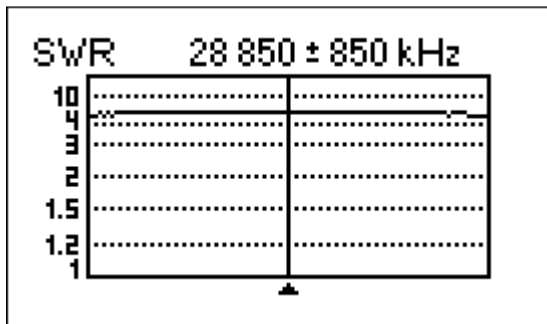

Show all 

28 850 kHz SWR: 6.1
Series model: |Z|: 16.2 Ω
R: 8.8 Ω X: -13.7 Ω
C: 404pF

Vertical

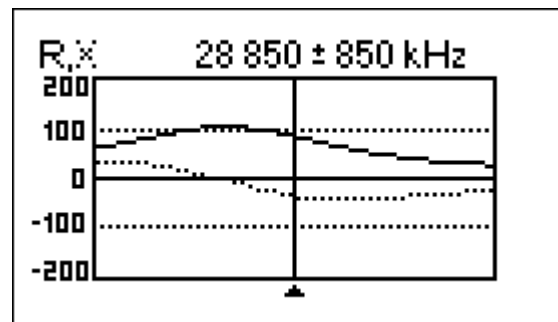
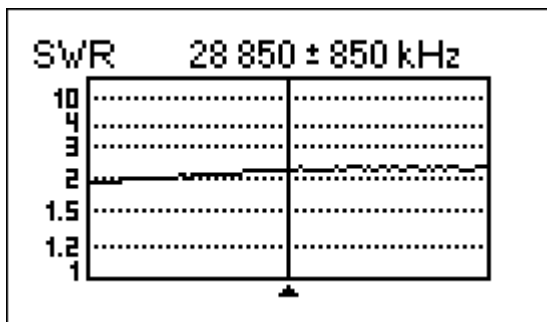



Show all 

28 850 kHz SWR: 2.2
Series model: |Z|: 96.4 Ω
R: 88.1 Ω X: -39.0 Ω
C: 141pF

12 metri: 24.890 – 24.990

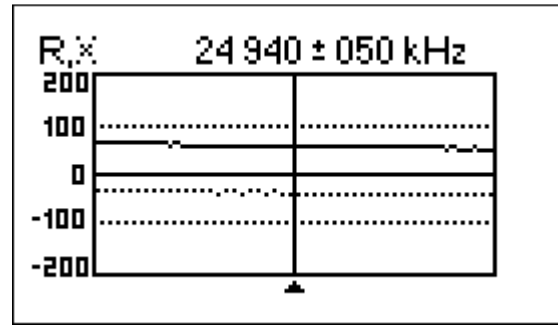
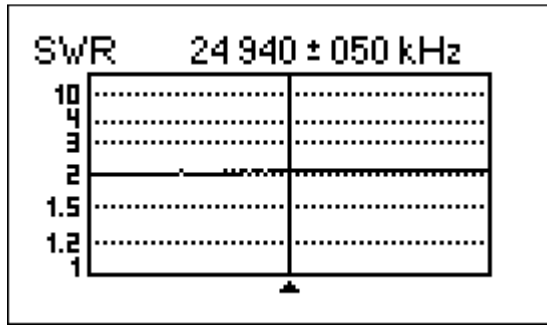
Delta MOPLK



Show all 

24 940 kHz SWR: 2.1
Series model: |Z|: 72.7 Ω
R: 60.6 Ω X: -40.1 Ω
C: 159pF

Vertical

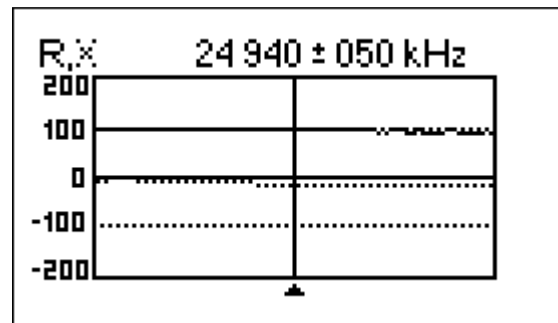
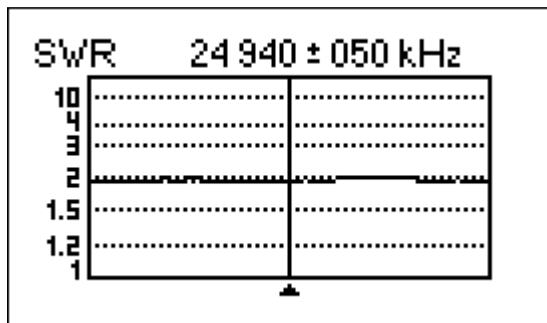



Show all 

24 940 kHz SWR: 2.1
Series model: |Z|: 99.3 Ω
R: 95.5 Ω X: -27.0 Ω
C: 236pF

15 metri: 21.000 – 21.450

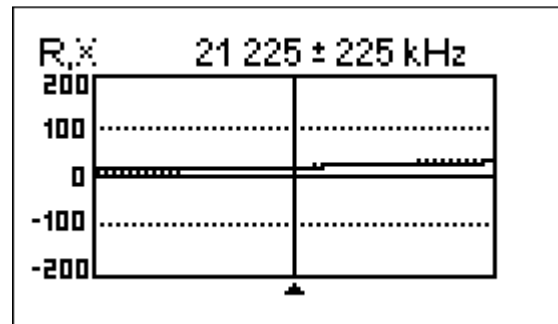
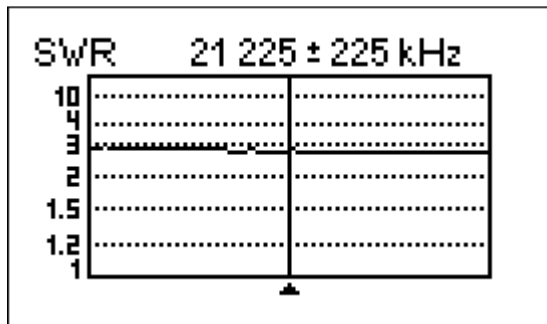
Delta MOPLK



Show all 

21 225 kHz SWR: 2.8
Series model: |Z|: 32.5 Ω
R: 22.7 Ω X: 23.2 Ω
L: 174nH

Vertical

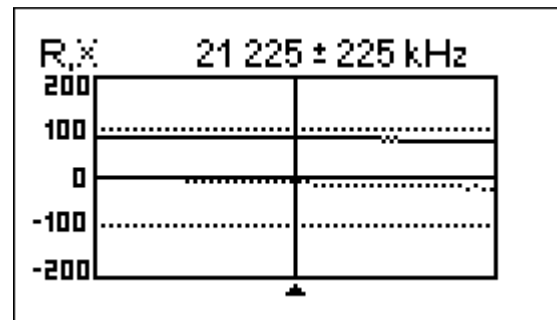
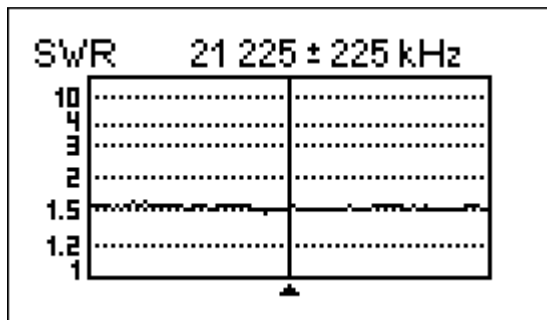

Show all 

21 225 kHz SWR: 1.8
Series model: |Z|: 86.3 Ω
R: 84.0 Ω X: -19.7 Ω
C: 379pF

17 metri: 18.068 – 18.168

Delta MOPLK

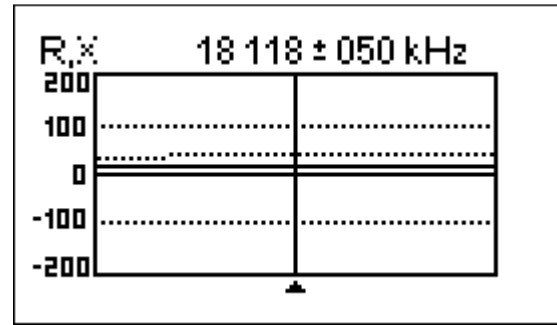
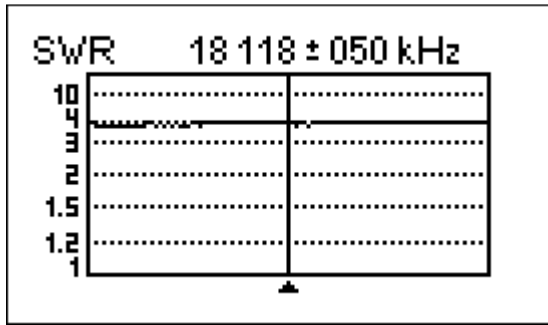

Show all

18 118 kHz SWR: 4.2
Series model: |Z|: 47.5 Ω
R: 21.5 Ω X: 42.4 Ω
L: 372nH

Vertical

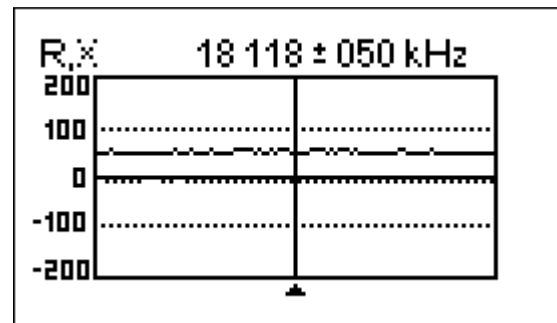
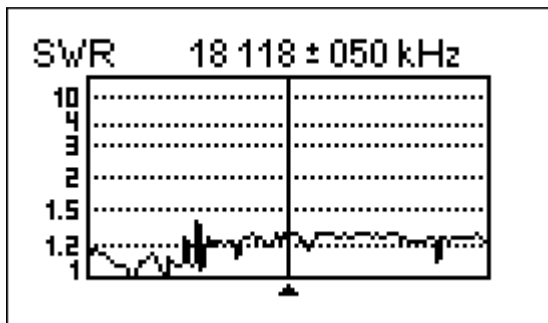



Show all 

18 118 kHz SWR: 1.6
Series model: |Z|: 64.6 Ω
R: 59.8 Ω X: -24.4 Ω
C: 359pF

20 metri: 14.000 – 14.350

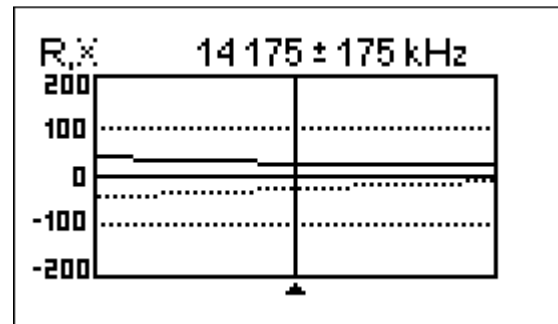
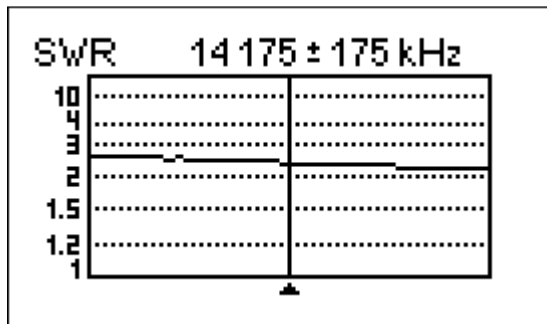
Delta MOPLK



Show all 

14 175 kHz SWR: 2.4
Series model: |Z|: 41.9 Ω
R: 30.5 Ω X: -28.7 Ω
C: 391pF

Vertical

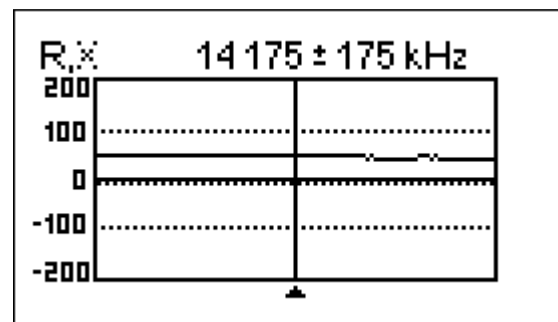
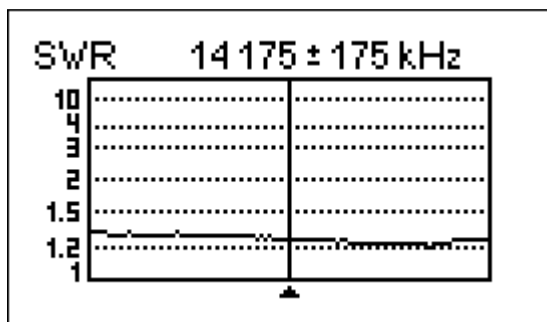



Show all 

14 175 kHz SWR: 1.35
Series model: |Z|: 59.8 Ω
R: 58.1 Ω X: -14.0 Ω
C: 801pF

30 metri: 10.100 – 10.130

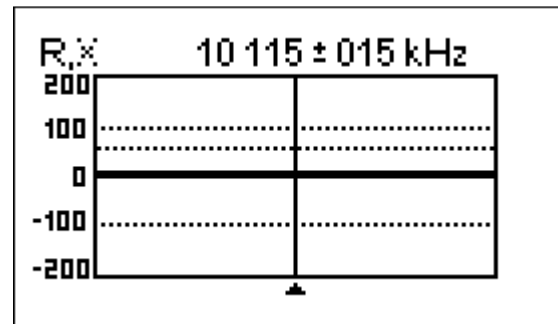
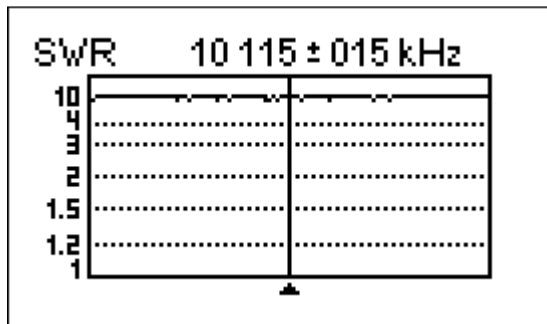
Delta MOPLK



Show all 

10 115 kHz SWR: 10.2
Series model: |Z|: 59.3 Ω
R: 11.7 Ω X: 58.1 Ω
L: 915nH

Vertical

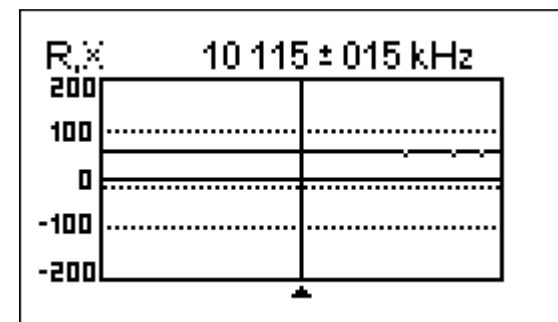
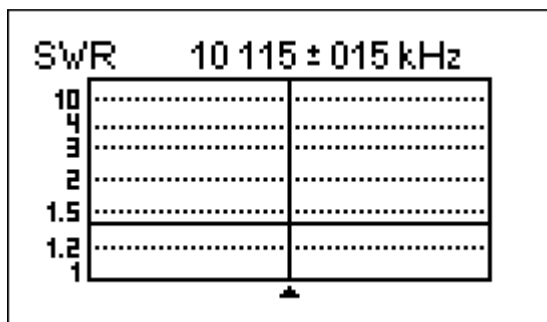

Show all 

10 115 kHz SWR: 1.41
Series model: |Z|: 58.4 Ω
R: 55.7 Ω X: -17.5 Ω
C: 898pF

40 metri: 7.000 – 7.200

Delta MOPLK

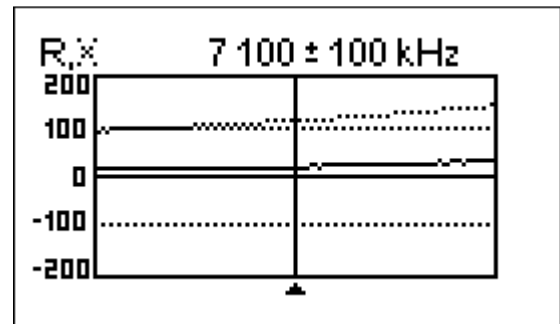
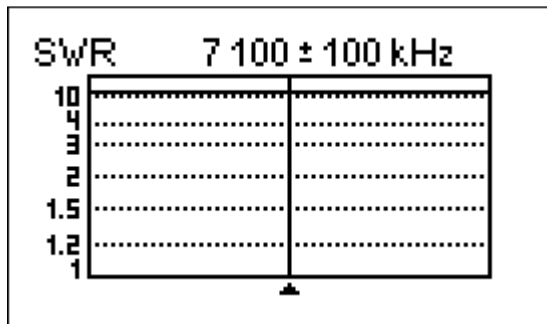

Show all

7 100 kHz SWR: 13.6
Series model: |Z|: 116.9 Ω
R: 23.6 Ω X: 114.5 Ω
L: 2568nH

Vertical

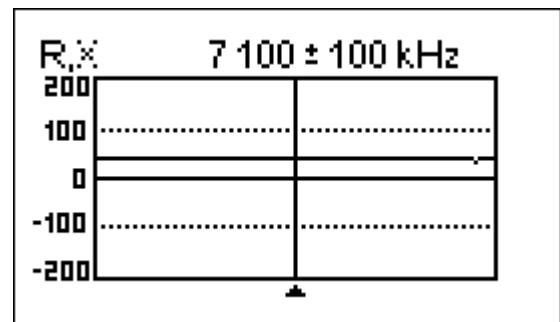
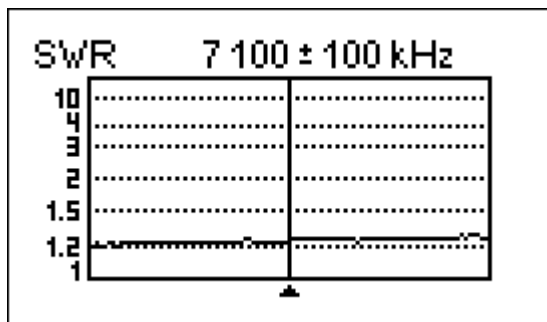

Show all

7 100 kHz SWR: 1.24
Series model: |Z|: 43.1 Ω
R: 42.6 Ω X: -6.5 Ω
C: 3419pF