

⚠ The base of this product has a matching section.
The element cannot be used with the base of the other models notwithstanding the same series.

User Manual

To use this product properly, read this instruction thoroughly before using it. Keep this instruction carefully at hand for later use.

Safety precautions

Labels

Risks of injury or damage from improper use are categorized by levels. Understand these labels before reading this guide

■ Denger and Warning mark.

⚠ DANGER Great risk of death or serious injury from improper use

⚠ WARNING Risk of death or serious injury from improper use

■ Make sure you understand the following symbols and precautions before reading this guide.

⚠ Danger and Warning: Please refer to the details after the symbol

⊘ Action prohibited: Please refer to the details after the symbol

! Action compulsory: Please refer to the details after the symbol

Limited liability

● Please note that use and misuse of product involves serious risks including injury, disability and death. Purchasers, users and participants assume all risk of injury. Diamond Antenna Corporation cannot and will not be responsible for the misuse or unauthorized and improper use of products sold through any of its distribution channels except the laws and regulations on liability is observed.

⚠ DANGER

- ⊘ Do not touch the antenna during transmission**
Touching the antenna during transmission may cause to electrify. Be sure to confirm to see if there is no one around the antenna if transmission is taking place while the car is parked.
- ⊘ Do not keep the antenna tilted**
The tip of the antenna becomes narrow. Always keep the antenna straight to avoid sticking the eyes or bodies. Install the antenna not to protrude from your car body.
- ⊘ Do not give a shock**
Strong impact can cause to break the antenna and may invite the accidents by falling the element. It is recommended to drive away from those obstacles such as branches.
- ⊘ Do not drive a car more than the regulation speed**
There is a possibility of falling down the antenna due to the high wind pressure or vibrations. Drive safely.

⚠ WARNING

- ⊘ Disassembly prohibited**
Do not disassemble the antenna. It may be damaged.
- ⚠ Inspect the antenna**
Nuts and screws can be loosened by vibration during driving. Be sure to check those fastening devices from time to time and refasten if necessary. The strength of the adhesive tape may be degraded by long-term use. Please check it periodically.

■ **Install the antenna** ※ Do not install the antenna where the tip of the antenna more than 3.8 meter high from the ground. Please confirm the antenna length and your vehicle high.

※ Install the antenna not to protrude from your car body. Confirm it when the element tilted too.

① Put the base on installation place without tearing off the tape once selected the installation place. Confirm if all base bottoms adhere to the location place. Be careful if installing the antenna on a curved place because the strength of the adhesive may be weaker and there is a possibility to drop the antenna.

※ Radialless antennas can be installed on the glass surface but do not install the antenna on a windshield or a place where is interfered your driving operations. Do not install the antenna where is interfered windshield wipers operations and on the windshield glass heater. Do not install the antenna on the glass of the slide door.

② Remove a dirt or oil of the installation place and dry the surface. If humid place, use a dryer.

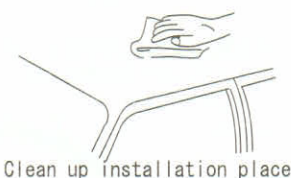
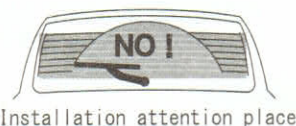
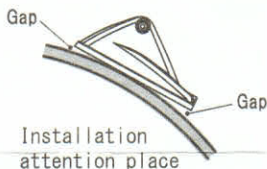

- ※ Normally, the adhesive tape requires more than 24 hours to have enough adhesive strength. Do not drive a car in 24 hours after installing the base with the elements.
- ※ If installing the antenna on the painted surface, the surface color of the installation place may be different from other surface. Particularly, pay attention to the influence of ultraviolet rays.

■ Coaxial cable wiring direction

M-connector is removability. When wiring the coaxial cable to the inside of a car, you can take the removing shell off and wire the cable into the fin hole. Turn the removing shell counterclockwise. If it is tight, please use a wrench. Please be sure to fasten the removing shell firmly not to drop it.

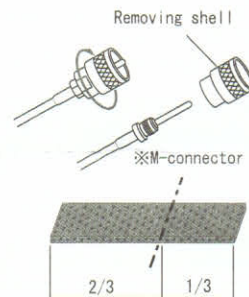

※ SMA connector is not removability.

Cut the waterproofing tape at the ration of 2:1. When wiring the coaxial cable into the inside of a car, stick the longer tape on the rubber gasket of the car. Put the coaxial cable on the center of the longer tape and stick the shorter tape.

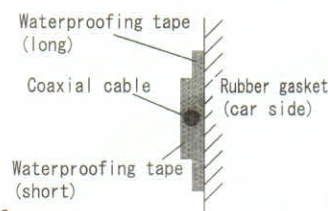

■ Angular adjustment of the antenna

The antenna element can be adjusted in all around 180 degrees. Adjust the antenna element vertically by loosening the bending screw of the upper hinge fitting and lower hinge fitting with the wrench (included). be sure to fasten the screw firmly after the adjustment.

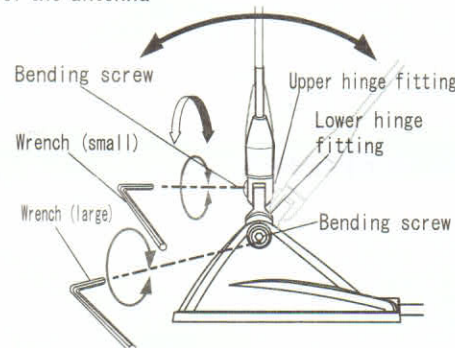

■ To remove the antenna element

When washing your car, the antenna element can be taken off. Please remove the antenna element by hands.

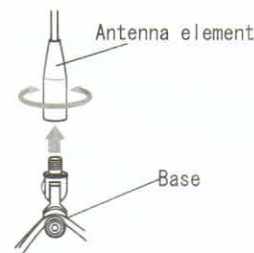

■ To remove the base

The base is adhered with the strong adhesive tape. Do not pull the base forcibly. When removing it, hang the kite string in the depth of the base and hold it by the hand of right and left. Pull it toward you slowly while drawing it out in right and left. The kite string may be cut if pulling toward you forcibly. If installing the antenna again, remove the adhesive tape and oil completely from the base. Use the brand-new adhesive tape (not included).

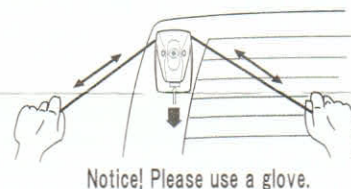

● Specifications

Please refer to the package.

- Though the product being purchased is manufactured under strict quality control, if damage is caused by transporting, ask your dealer promptly.
- Design and specification of these products will be changed for future improvement without advance notice.

Copyright 2014/Oct. Diamond Antenna Corporation

