

MMANA-GAL v. 1.2.0.20

4ele 10m (14mm/12mm/10mm Pipe)

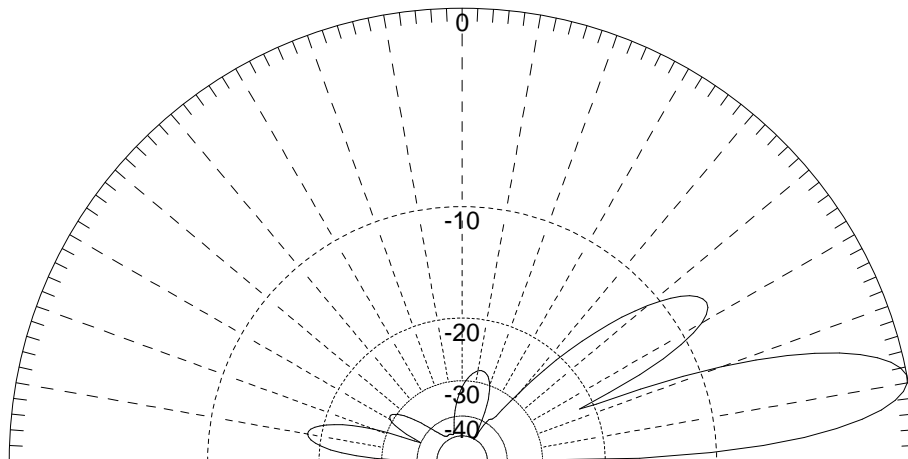
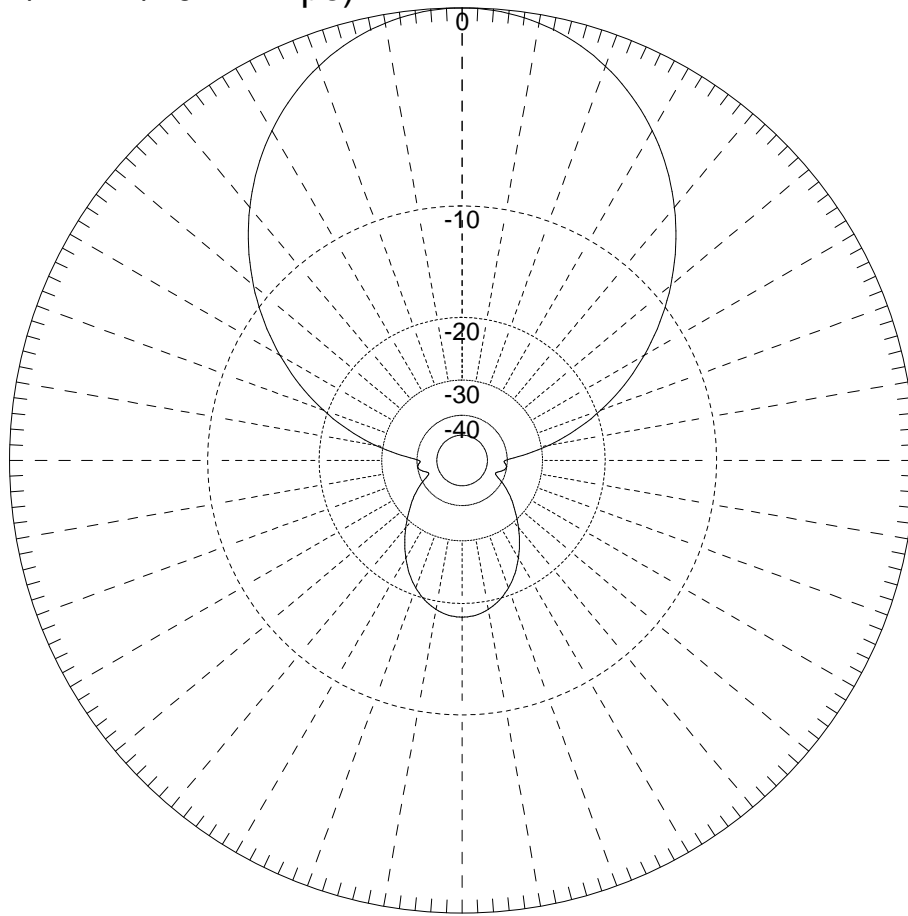

Ga : 16.24 dBi = 0 dB (Horizontal polarization)
F/B: 18.40 dB; Rear: Azim. 120 dg, Elev. 60 dg
Freq: 28.500 MHz
Z: 28.024 - j0.304 Ohm
SWR: 1.8 (50.0 Ohm),
Elev: 10.6 dg (Real GND :10.00 m height)